

reversible motor - series XV

XV-3M

SAE B TYPE MOTOR
ø101.6 FLANGE - SPLINED SHAFT

X 3 M 78 31 I O O E

Series	X	series XV
Group	3	group 3
Category	M	reversible motor
Displacement	78	38
Flange	31	Ø101.6 SAE B reversible rotation
Shaft	I	SCF04 - Splined ø21.81 z=13, H=33.55 SAE J498-13T -16/32DP (SAE B)
Body	IN	inlet - SAE 30,18 X 58,72 - ø32 - 7/16-14UNC-2B
	OUT	outlet - SAE 30,18 X 58,72 - ø32 - 7/16-14UNC-2B
Cover	E	with external drainage

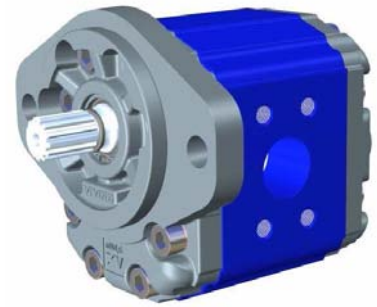

XM332

Technical data table

TYPE	Displacement cm3/rev	Max. Pressure		CODE	
		P1 bar	P3 bar	External drainage	Internal drainage
XV-3M/15	14,89	250	270	X 3 M 66 31 I N N E	X 3 M 66 31 I N N F
XV-3M/18	17,37	250	270	X 3 M 68 31 I N N E	X 3 M 68 31 I N N F
XV-3M/21	21,10	250	270	X 3 M 70 31 I N N E	X 3 M 70 31 I N N F
XV-3M/27	26,97	250	270	X 3 M 72 31 I N N E	X 3 M 72 31 I N N F
XV-3M/32	32,27	250	270	X 3 M 74 31 I O O E	X 3 M 74 31 I O O F
XV-3M/38	38,47	250	270	X 3 M 78 31 I O O E	X 3 M 78 31 I O O F
XV-3M/43	43,44	250	270	X 3 M 79 31 I O O E	X 3 M 79 31 I O O F
XV-3M/47	47,16	230	250	X 3 M 80 31 I O O E	X 3 M 80 31 I O O F
XV-3M/51	50,88	230	250	X 3 M 81 31 I O O E	X 3 M 81 31 I O O F
XV-3M/54	54,60	230	250	X 3 M 82 31 I O O E	X 3 M 82 31 I O O F
XV-3M/61	60,81	230	250	X 3 M 83 31 I P P E	X 3 M 83 31 I P P F
XV-3M/64	64,53	210	230	X 3 M 85 31 I P P E	X 3 M 85 31 I P P F
XV-3M/70	70,74	200	220	X 3 M 86 31 I P P E	X 3 M 86 31 I P P F
XV-3M/74	74,46	180	200	X 3 M 87 31 I P P E	X 3 M 87 31 I P P F
XV-3M/90	86,87	150	170	X 3 M 89 31 I P P E	X 3 M 89 31 I P P F

P1) Max. working pressure - P3) Max. peak pressure

For heavy-duty applications, it is recommended to check the admissible torque of the shaft

Dimensions table

TYPE	Weight kg	A mm	B mm	D	E	F	G
XV-3M/15	7,010	124,0	61,0	ø25	52,37	26,19	3/8-16UNC-2B
XV-3M/18	7,070	126,0	62,0	ø25	52,37	26,19	3/8-16UNC-2B
XV-3M/21	7,150	129,0	63,5	ø25	52,37	26,19	3/8-16UNC-2B
XV-3M/27	7,250	133,0	65,5	ø25	52,37	26,19	3/8-16UNC-2B
XV-3M/32	7,390	138,0	68,0	ø32	58,72	30,18	7/16-14UNC-2B
XV-3M/38	7,520	143,0	70,5	ø32	58,72	30,18	7/16-14UNC-2B
XV-3M/43	7,630	147,0	72,5	ø32	58,72	30,18	7/16-14UNC-2B
XV-3M/47	7,710	150,0	74,0	ø32	58,72	30,18	7/16-14UNC-2B
XV-3M/51	7,790	153,0	75,5	ø32	58,72	30,18	7/16-14UNC-2B
XV-3M/54	7,870	156,0	77,0	ø32	58,72	30,18	7/16-14UNC-2B
XV-3M/61	8,010	161,0	79,5	ø38	69,85	35,71	1/2-13UNC-2B
XV-3M/64	8,090	164,0	81,0	ø38	69,85	35,71	1/2-13UNC-2B
XV-3M/70	8,220	169,0	83,5	ø38	69,85	35,71	1/2-13UNC-2B
XV-3M/74	8,300	172,0	85,0	ø38	69,85	35,71	1/2-13UNC-2B
XV-3M/90	8,570	182,0	90,0	ø38	69,85	35,71	1/2-13UNC-2B

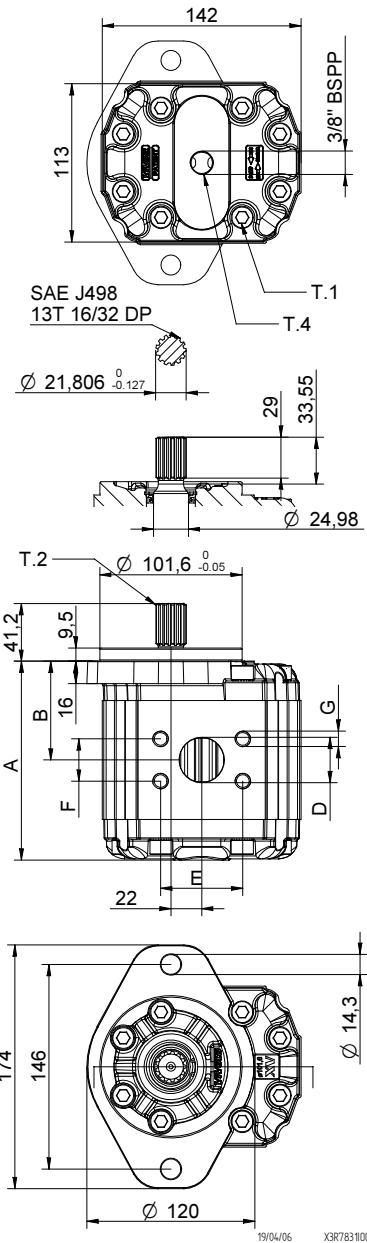

T.1 = 60÷65 [Nm] - screw tightening torque M10

T.2 = 264 [Nm] - admissible shaft torque (N.B. When choosing a shaft, always check the admissible torque).

T.4 = 0.3÷0.5 bar - max. drainage pressure

Table of variations

XV-3M

ø101.6 FLANGE ""SAE B""

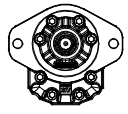
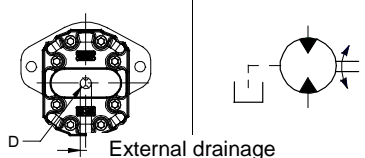
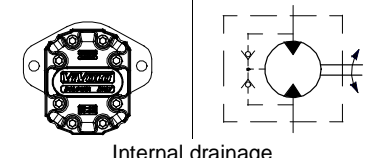
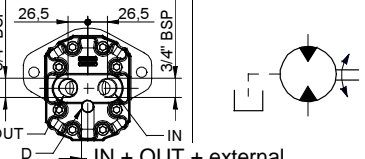
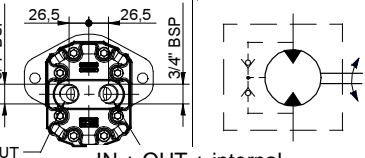
	Shaft		Cover			
	CO001 - Tapered T.2 = 482 [Nm]	A	CI001 - Parallel T.2 = 181 [Nm]	B	 External drainage	E
	SCF03 - Splined T.2 = 223 [Nm]	C	CI004 - Parallel T.2 = 180 [Nm]	H	 Internal drainage	F
	SCF04 - Splined T.2 = 264 [Nm]	I			 IN + OUT + external	K
				 IN + OUT + internal	L	

Displacement	
TYPE	CODE
XV-3M/15	66
XV-3M/18	68
XV-3M/21	70
XV-3M/27	72
XV-3M/32	74
XV-3M/38	78
XV-3M/43	79
XV-3M/47	80
XV-3M/51	81
XV-3M/54	82
XV-3M/61	83
XV-3M/64	85
XV-3M/70	86
XV-3M/74	87
XV-3M/90	89

Standard bodies				
Displacement cm ³ /rev	Standard threads			
	15	A - A	D - D	H - H
18	A - A	D - D	H - H	
21	A - A	D - D	H - H	
27	A - A	E - E	H - H	
32	B - B	E - E	H - H	
38	B - B	E - E	H - H	
43	B - B	E - E	H - H	
47	B - B	E - E	H - H	
51	B - B	E - E	H - H	
54	B - B	E - E	H - H	
61	C - C	F - F		
64	C - C	F - F		
70	C - C	F - F		
74	C - C	F - F		
90	C - C	F - F		

Table showing standard flange and thread combinations available in stock

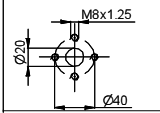
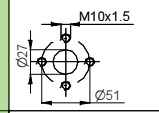
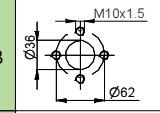
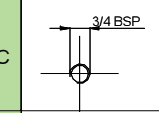
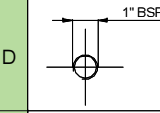
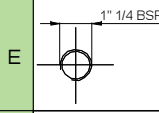
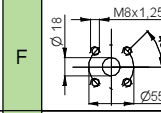
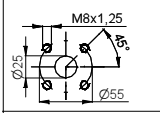
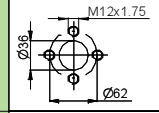
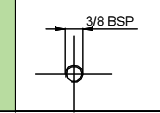
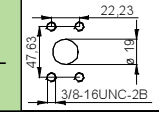
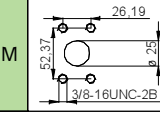
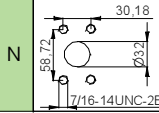
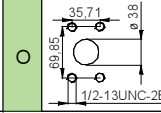
Body (threads/flanges)													
	A		B		C		D		E		F		G
	H		I		L		M		N		O		P
Closed Body	Z												